

HIGH POWER INDUCTOR

P7614 Family

Features

- * Lead-free (Pb-free)
- * RoHS compliant
- * High Current (to 75A Saturation)
- * Low DCR (to 0.7mΩ)
- * Powder core
- * Low profile (to 2mm)
- * Wide temperature range (to -55°C)
- * Closed magnetic circuit
- * Flat top for pick and place

Applications

- * DC-DC Converters
- * Voltage Regulator Modules
- * Distributed Power
- * MPU power supplies
- * PDA/Notebook/Desktop/Server
- * Telecom equipment
- * Notebook and handheld equipment

DESCRIPTION

The P7614 family comprises high-energy-density surface mount inductors for high current power converters. The family handles large transient current spikes without saturation. Inductance values are available as low as 0.1μH.

Components are available in ten mechanical sizes, all offering high energy storage and current handling in very low profile packages, and offer operating temperature down to -55°C.

A distributed gap powder core is used, yielding stable inductance at very high currents. The core material is moulded over the winding and provides a robust, self shielded structure that operates over a wide temperature range.

The P7614 family of components is compliant with RoHS Directive 2002/95/EC, and is suitable for Pb-free and conventional placement and reflow.

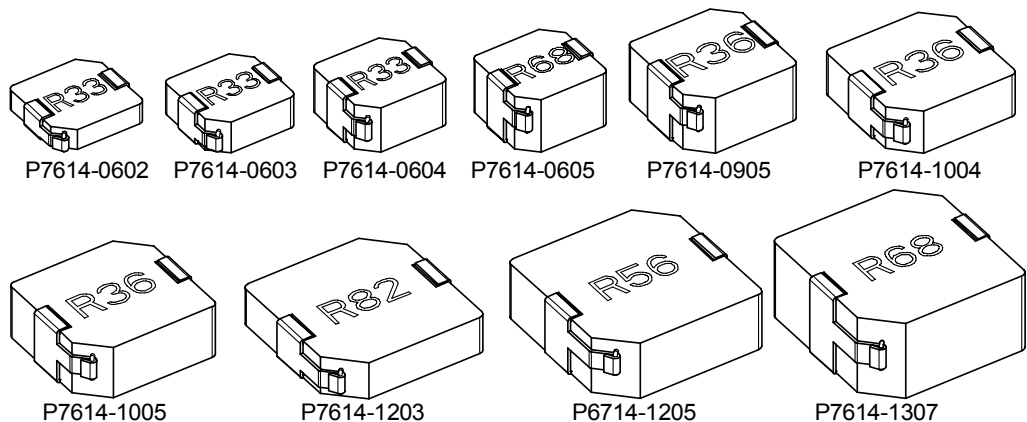

SPECIFICATIONS

Electrical

(Measured at T=25°, unless otherwise stated)

For notes, see end of tables, foot of page 5

0602 size

Part Number	Inductance (μH) ⁽¹⁾	DCR (m Ω) Max	I _{RMS} (A) ⁽²⁾	I _{sat} (A) ⁽³⁾
P7614-0602-R10M	0.10±20%	3.5	18	40
P7614-0602-R15M	0.15±20%	5.2	15	28
P7614-0602-R22M	0.22±20%	5.7	14	26
P7614-0602-R33M	0.33±20%	7.0	12	18
P7614-0602-R47M	0.47±20%	9.3	11	18
P7614-0602-R68M	0.68±20%	13.9	9.0	17
P7614-0602-R82M	0.82±20%	15.9	8.0	15
P7614-0602-1R0M	1.0±20%	18	7.0	14
P7614-0602-1R5M	1.5±20%	34	4.0	12
P7614-0602-2R2M	2.2±20%	46	5.0	9.0
P7614-0602-2R5M	2.5±20%	52	3.5	8.0
P7614-0602-3R3M	3.3±20%	60	3.25	7.0
P7614-0602-4R7M	4.7±20%	78	3.0	5.0

0603 size

Part Number	Inductance (μH) ⁽¹⁾	DCR (m Ω) Max	I _{RMS} (A) ⁽²⁾	I _{sat} (A) ⁽³⁾
P7614-0603-R10M	0.10±20%	1.7	32.5	42
P7614-0603-R15M	0.15±20%	2.5	26	38
P7614-0603-R20M	0.20±20%	3.0	24	36
P7614-0603-R22M	0.22±20%	2.8	23	36
P7614-0603-R33M	0.33±20%	3.9	20	30
P7614-0603-R47M	0.47±20%	4.2	17.5	26
P7614-0603-R68M	0.68±20%	5.5	15.5	23
P7614-0603-R82M	0.82±20%	8.0	13	20
P7614-0603-1R0M	1.0±20%	10	11	16
P7614-0603-1R5M	1.5±20%	15	9.0	14
P7614-0603-1R8M	1.8±20%	20	9.0	17
P7614-0603-2R2M	2.2±20%	20	8.0	12
P7614-0603-3R3M	3.3±20%	30	6.0	10
P7614-0603-4R7M	4.7±20%	40	5.5	6.5
P7614-0603-6R8M	6.8±20%	60	4.5	6.0
P7614-0603-8R2M	8.2±20%	68	4.0	5.5
P7614-0603-100M	10±20%	105	3.0	4.5

0604 size

Part Number	Inductance (μH) ⁽¹⁾	DCR (m Ω) Max	I _{RMS} (A) ⁽²⁾	I _{sat} (A) ⁽³⁾
P7614-0604-R33M	0.33±20%	1.4	23	32
P7614-0604-R47M	0.47±20%	2.0	20	30
P7614-0604-R68M	0.68±20%	3.8	17	28
P7614-0604-R82M	0.82±20%	5.0	15	24
P7614-0604-1R0M	1.0±20%	7.0	13	20
P7614-0604-1R2M	1.2±20%	8.0	12	18
P7614-0604-1R5M	1.5±20%	10	11	16
P7614-0604-1R8M	1.8±20%	13	10.5	14
P7614-0604-2R2M	2.2±20%	15	10	14
P7614-0604-3R3M	3.3±20%	18	7.0	11
P7614-0604-4R7M	4.7±20%	21	6.0	9.0
P7614-0604-5R6M	5.6±20%	30	5.5	7.0
P7614-0604-6R8M	6.8±20%	32	5.0	7.0

0605 size

Part Number	Inductance (μH) ⁽¹⁾	DCR (m Ω) Max	I _{RMS} (A) ⁽²⁾	I _{sat} (A) ⁽³⁾
P7614-0605-R39M	0.39±20%	2.6	21	30
P7614-0605-R68M	0.68±20%	3.8	18	28
P7614-0605-1R0M	1.0±20%	4.2	15	22
P7614-0605-1R5M	1.5±20%	5.4	16	18
P7614-0605-2R2M	2.2±20%	8.2	13	15
P7614-0605-3R3M	3.3±20%	15.2	10	13
P7614-0605-4R7M	4.7±20%	19	7	10
P7614-0605-6R8M	6.8±20%	30	6	8
P7614-0605-100M	10±20%	45	5	6

0905 size

Part Number	Inductance (μH) ⁽¹⁾	DCR (m Ω) Max	I _{RMS} (A) ⁽²⁾	I _{sat} (A) ⁽³⁾
P7614-0905-R10M	0.10±20%	0.7	40	45
P7614-0905-R20M	0.20±20%	0.8	35	45
P7614-0905-R36M	0.36±20%	1.2	32	40
P7614-0905-R47M	0.47±20%	1.5	30	38
P7614-0905-R56M	0.56±20%	1.8	28	36
P7614-0905-R68M	0.68±20%	2.4	23	32
P7614-0905-R82M	0.82±20%	2.4	20	25
P7614-0905-1R0M	1.0±20%	3.8	18	22
P7614-0905-1R5M	1.5±20%	4.5	15	20
P7614-0905-2R2M	2.2±20%	5.4	12	16
P7614-0905-3R3M	3.3±20%	7.1	10	14
P7614-0905-4R7M	4.7±20%	12.3	9.0	13
P7614-0905-5R6M	5.6±20%	14.5	8.0	12
P7614-0905-6R8M	6.8±20%	20.5	7.0	11
P7614-0905-8R2M	8.2±20%	22	6.0	10
P7614-0905-100M	10.0±20%	27	5.0	9.0

1004 size

Part Number	Inductance (μH) ⁽¹⁾	DCR (m Ω) Max	I _{RMS} (A) ⁽²⁾	I _{sat} (A) ⁽³⁾
P7614-1004-R20M	0.20±20%	1.0	32	40
P7614-1004-R36M	0.36±20%	1.4	28	40
P7614-1004-R47M	0.47±20%	1.6	26	38
P7614-1004-R56M	0.56±20%	1.9	25	36
P7614-1004-R68M	0.68±20%	2.4	23	32
P7614-1004-1R0M	1.0±20%	3.5	20	28
P7614-1004-1R5M	1.5±20%	7.5	12	20
P7614-1004-2R2M	2.2±20%	8.6	11.5	16.5
P7614-1004-3R3M	3.3±20%	10.0	10.0	14
P7614-1004-4R7M	4.7±20%	13.5	8.0	13
P7614-1004-5R6M	5.6±20%	16.0	7.0	12
P7614-1004-8R2M	8.2±20%	32.5	5.0	8
P7614-1004-100M	10.0±20%	35.0	5.0	9

1005 size

Part Number	Inductance (μH) ⁽¹⁾	DCR (m Ω) Max	I _{RMS} (A) ⁽²⁾	I _{sat} (A) ⁽³⁾
P7614-1005-R36M	0.36±20%	0.8	35	40
P7614-1005-R47M	0.47±20%	0.9	32	38
P7614-1005-R56M	0.56±20%	1.1	30	36
P7614-1005-R68M	0.68±20%	1.3	29	32
P7614-1005-1R0M	1.0±20%	2.2	24	28
P7614-1005-1R5M	1.5±20%	2.6	20	22
P7614-1005-2R2M	2.2±20%	4.0	17	20

1203 size

Part Number	Inductance (μH) ⁽¹⁾	DCR (m Ω) Max	I _{RMS} (A) ⁽²⁾	I _{sat} (A) ⁽³⁾
P7614-1203-R10M	0.10±20%	0.96	43	56
P7614-1203-R15M	0.15±20%	1.2	41	50
P7614-1203-R22M	0.22±20%	1.3	38.5	50
P7614-1203-R32M	0.33±20%	1.5	36.5	50
P7614-1203-R47M	0.47±20%	2.0	32	44
P7614-1203-R60M	0.60±20%	2.5	29	42
P7614-1203-R68M	0.68±20%	2.5	28	40
P7614-1203-R82M	0.82±20%	3.0	25	38
P7614-1203-1R0M	1.0±20%	3.5	24	36
P7614-1203-1R5M	1.5±20%	5.5	19	28
P7614-1203-1R8M	1.8±20%	7.0	16.5	24
P7614-1203-2R2M	2.2±20%	8.0	16	20
P7614-1203-3R3M	3.3±20%	12	12	18
P7614-1203-4R7M	4.7±20%	15	10	16
P7614-1203-5R6M	5.6±20%	18	10	14
P7614-1203-6R8M	6.8±20%	22	9.0	13
P7614-1203-8R2M	8.2±20%	28	8.5	12
P7614-1203-100M	10.0±20%	34	7.0	9.5

1205 size

Part Number	Inductance (μH) ⁽¹⁾	DCR (m Ω) Max	I _{RMS} (A) ⁽²⁾	I _{sat} (A) ⁽³⁾
P7614-1205-R36M	0.36 \pm 20%	1.1	41	75
P7614-1205-R47M	0.47 \pm 20%	1.3	38	65
P7614-1205-R56M	0.56 \pm 20%	1.5	36	55
P7614-1205-R68M	0.68 \pm 20%	1.7	34	54
P7614-1205-1R0M	1.0 \pm 20%	2.5	29	50
P7614-1205-1R5M	1.5 \pm 20%	4.1	23	48
P7614-1205-2R2M	2.2 \pm 20%	5.5	20	32
P7614-1205-3R3M	3.3 \pm 20%	9.2	15	32
P7614-1205-4R7M	4.7 \pm 20%	15	16	27
P7614-1205-6R8M	6.8 \pm 20%	18	13	21
P7614-1205-8R2M	8.2 \pm 20%	14	9.5	18
P7614-1205-100M	10.0 \pm 20%	18	9.0	16
P7614-1205-120M	12.0 \pm 20%	18	7.5	10

1307 size

Part Number	Inductance (μH) ⁽¹⁾	DCR (m Ω) Max	I _{RMS} (A) ⁽²⁾	I _{sat} (A) ⁽³⁾
P7614-1307-R47M	0.47 \pm 20%	1.2	41	65
P7614-1307-R68M	0.68 \pm 20%	1.6	35	60
P7614-1307-1R0M	1.0 \pm 20%	2.1	32	50
P7614-1307-1R5M	1.5 \pm 20%	2.6	27	48
P7614-1307-2R2M	2.2 \pm 20%	4.2	22	40
P7614-1307-3R3M	3.3 \pm 20%	6.8	18	35
P7614-1307-4R7M	4.7 \pm 20%	11.2	15	30
P7614-1307-6R8M	6.8 \pm 20%	14	12	21
P7614-1307-100M	10.0 \pm 20%	17	10	16

Notes

1. Inductance measured at 100kHz, 250mV.
2. I_{RMS} is the current at which the temperature rise is 40°C typical, neglecting core losses.
3. I_{sat} is the DC current at which the zero-current inductance drops by 20%.
4. Operating temperature (part, i.e. ambient + temp rise) -55°C to +125°C.
5. Not recommended for continuous body temperature in excess of 100°C in order to avoid thermal ageing, refer to fig. 11.
6. For non-standard inductance values, please contact Profec.

CONSTRUCTION

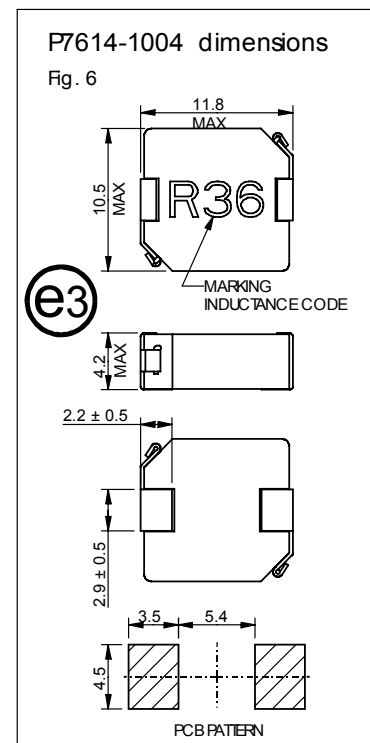
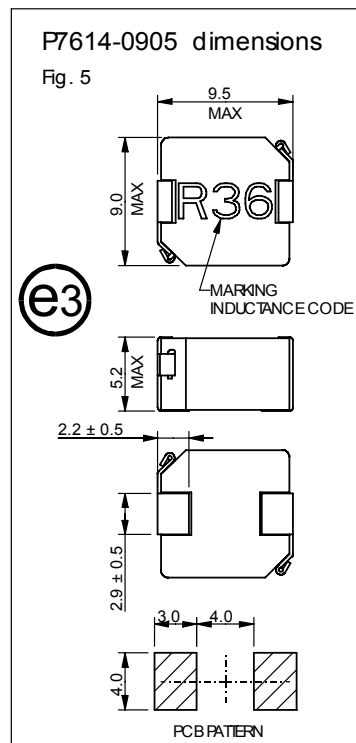
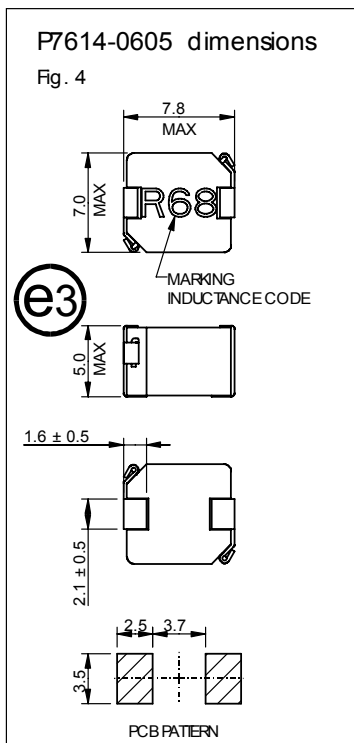
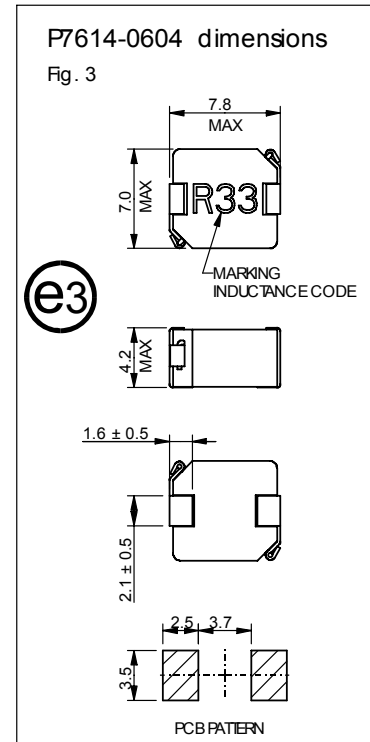
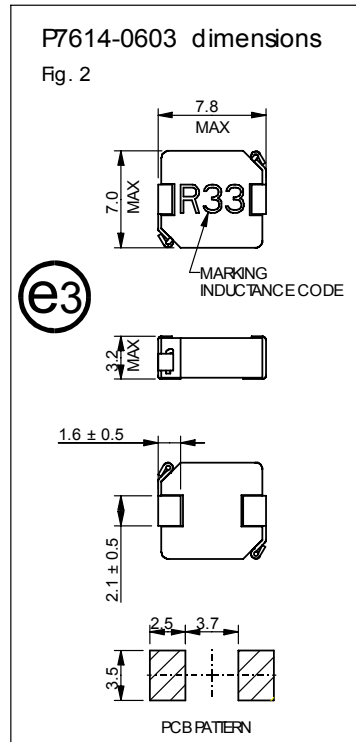
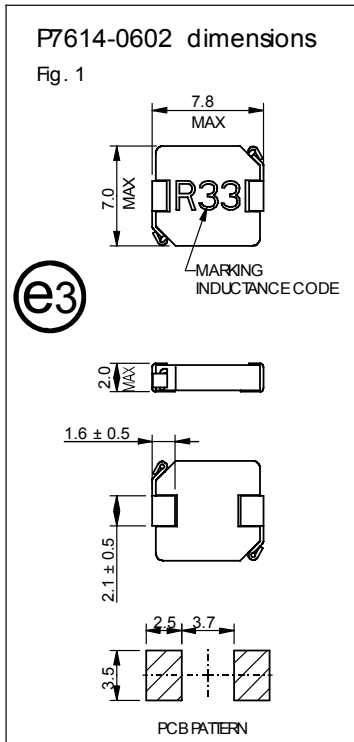

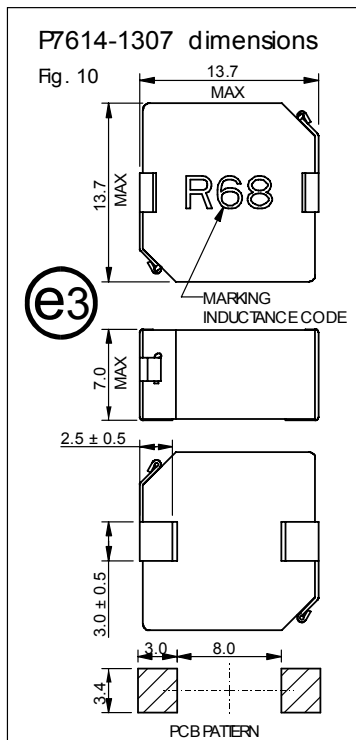
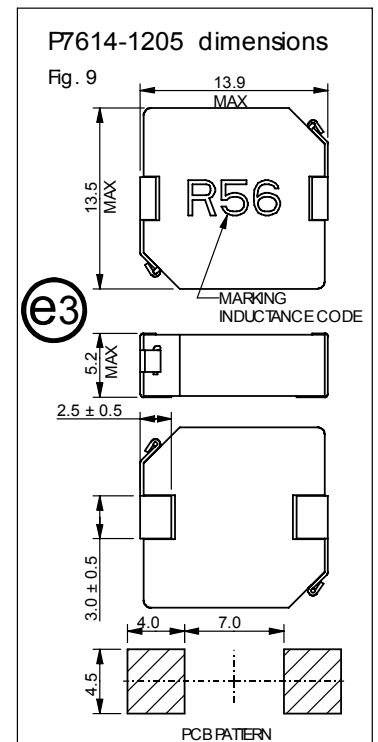
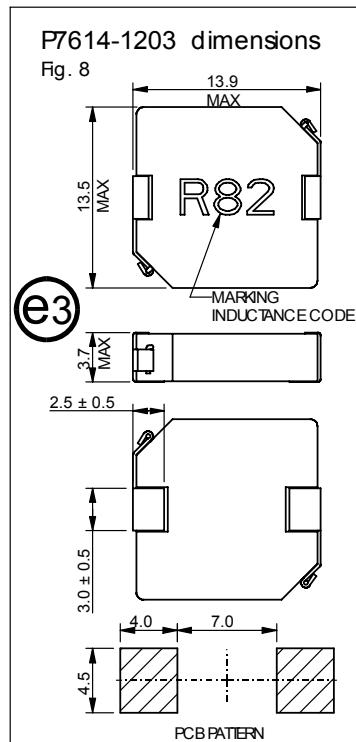
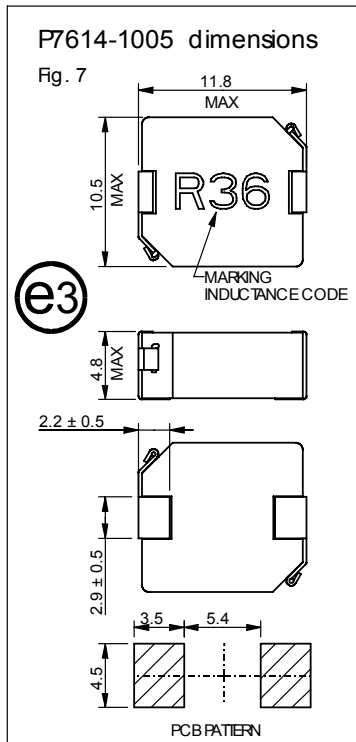

Recommended reflow solder profile:
2 minutes @ 150-200°C,
10 seconds @ 260°C;
time above 217°C 60 seconds
maximum.

Dimensions shown are in millimetres

Terminal plating JESD97 category = e3

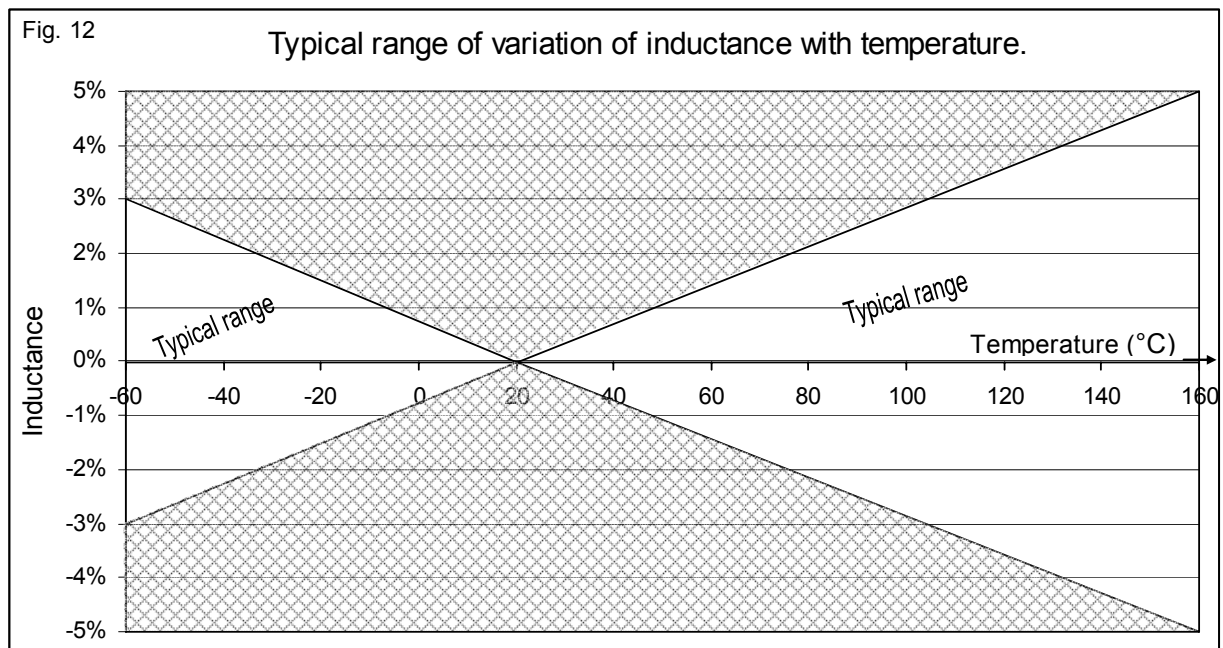
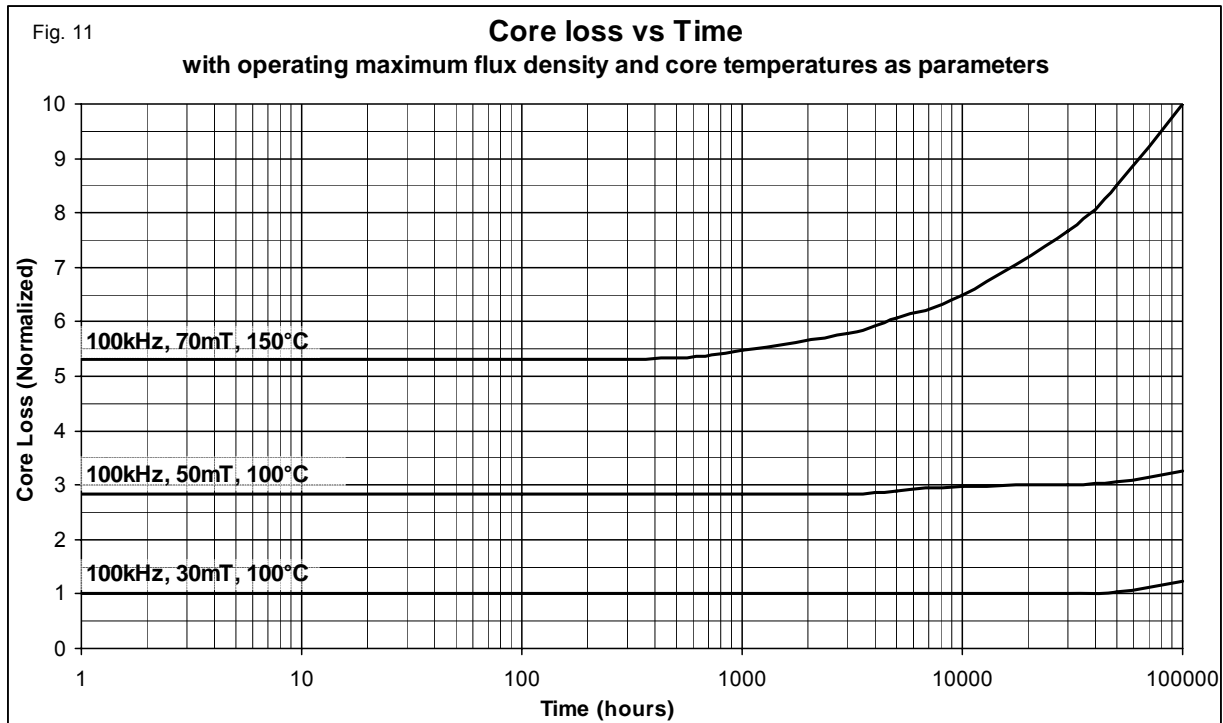

ORDERING CODE

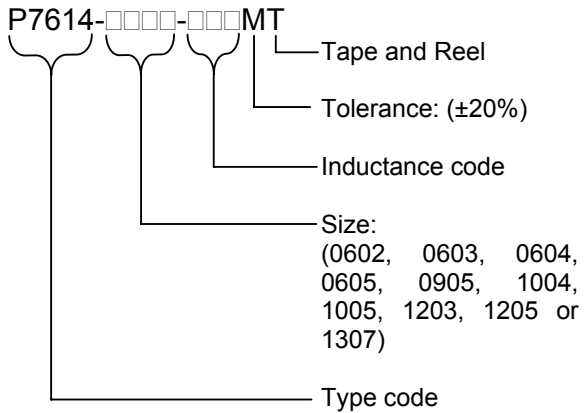

ABSOLUTE MAXIMUM RATINGS

Storage temperature	-15°C to +40°C
Operating temperature	-55°C to +125°C
Continuous component body temperature (1,000,000 hours)	+100°C
Soldering temperature profile peak	260°C 10s

Handle in accordance with IPC/JEDEC J-STD-033 procedure for components classified as IPC/JEDEC J-STD-020 Moisture Sensitivity Level 2.